

9115/2
for drawing

9115/1E
2nd

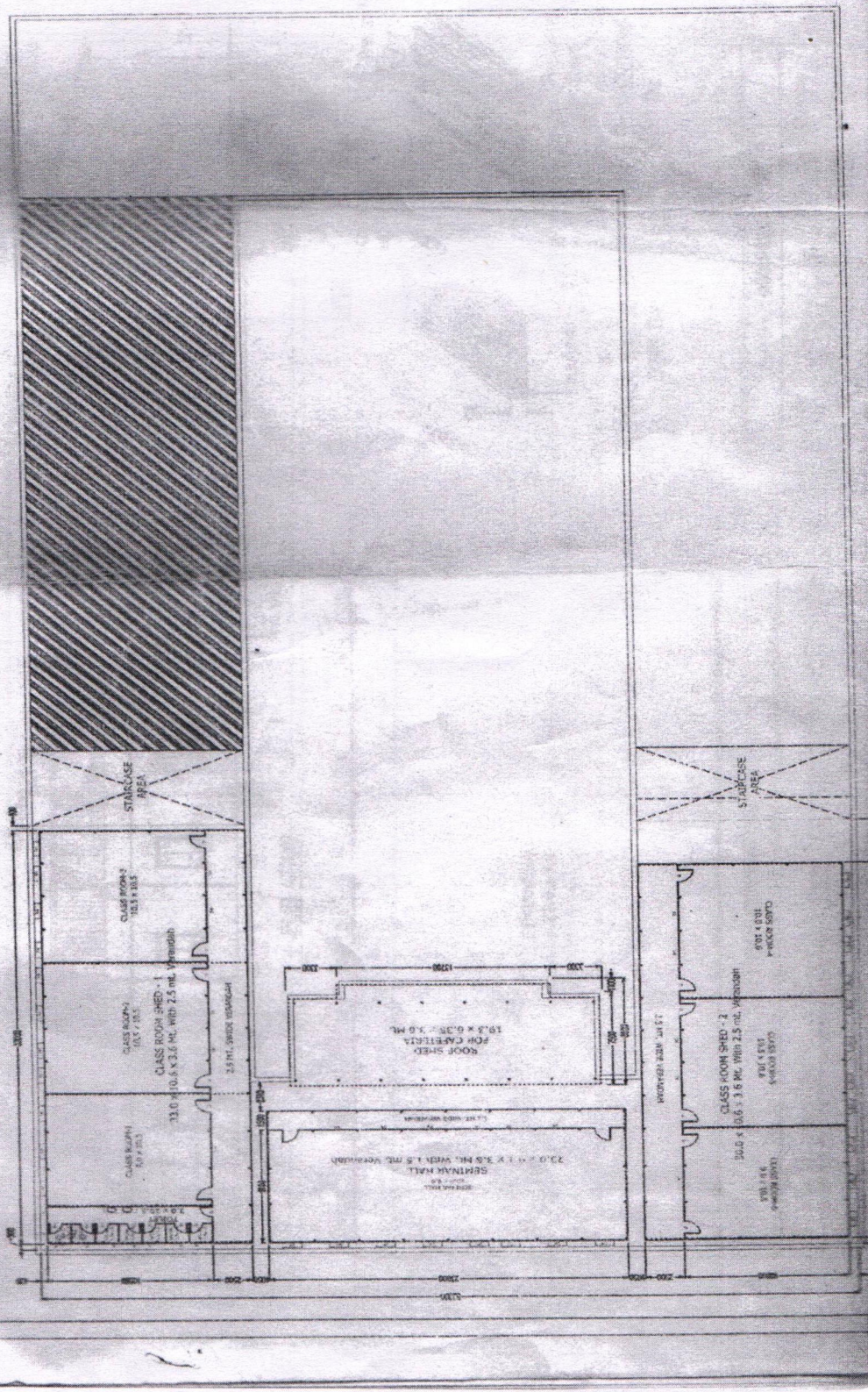

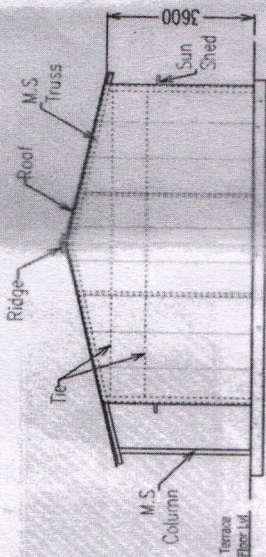

SIDE VIEW

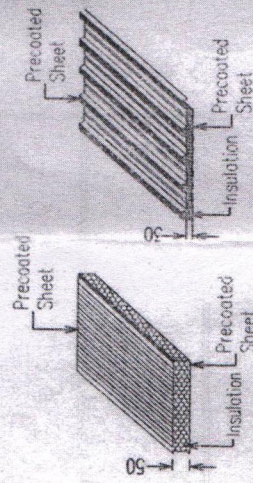

TYPICAL ROOF SECTION
30MM Thk.

TYPICAL WALL SECTION
50MM Thk.

DOOR-WINDOW DETAIL

D	DOOR	1000 x 2000mm.
SW	ALL SLIDING WINDOW	1000 x 1200mm.

Handwritten signature and date: 27/11/16

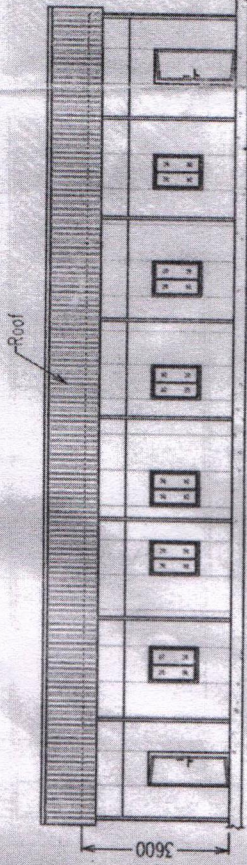

ELEVATION

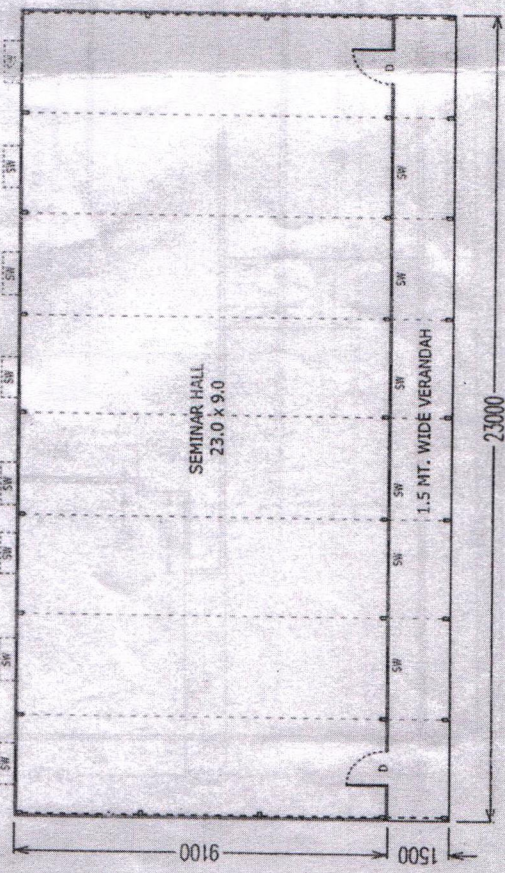

ELEVATION

Handwritten signature and date: 27/11/16

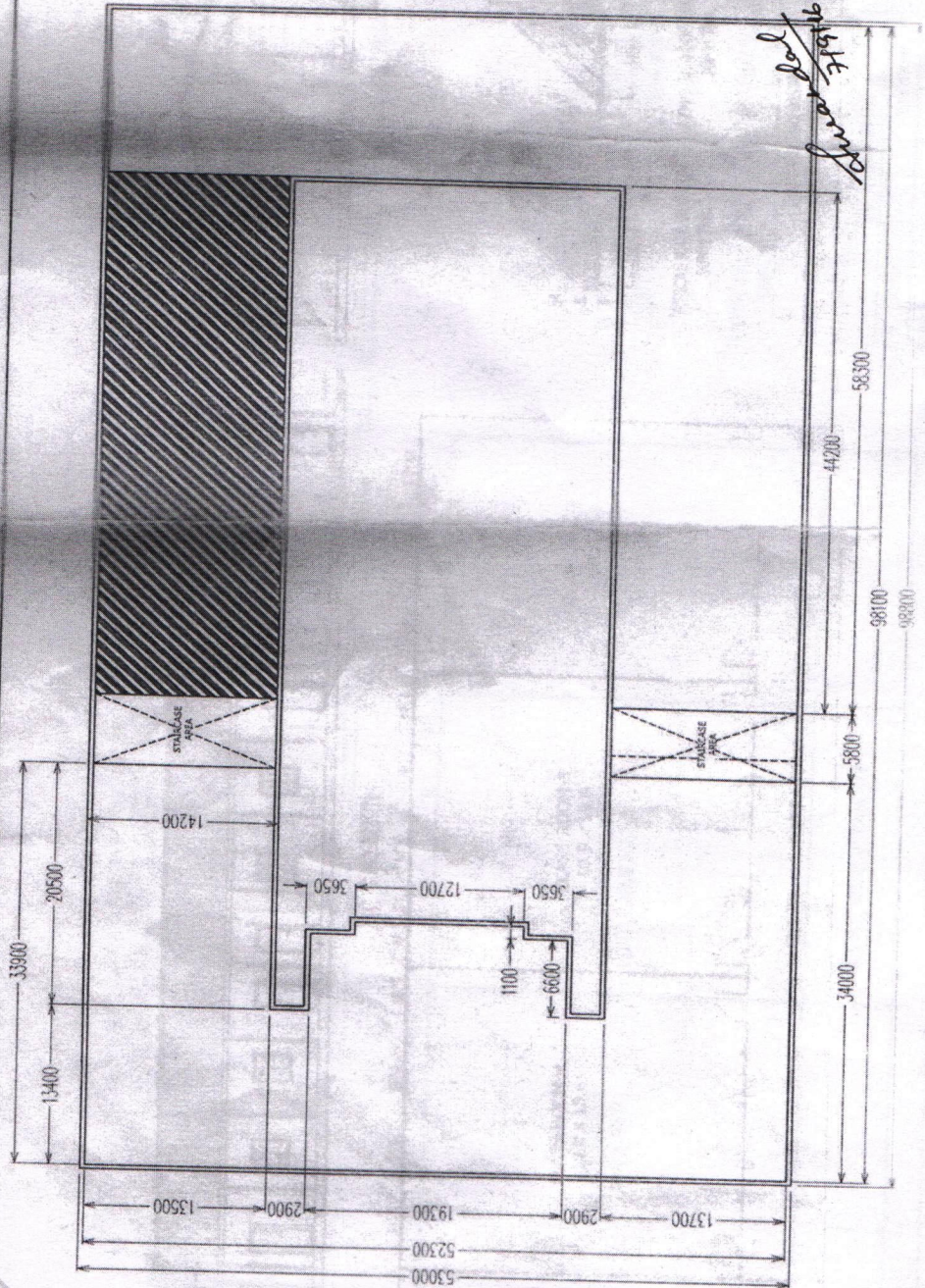

Roof

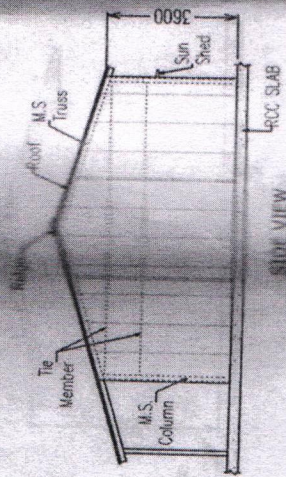

ELEVATION

Roof

3600

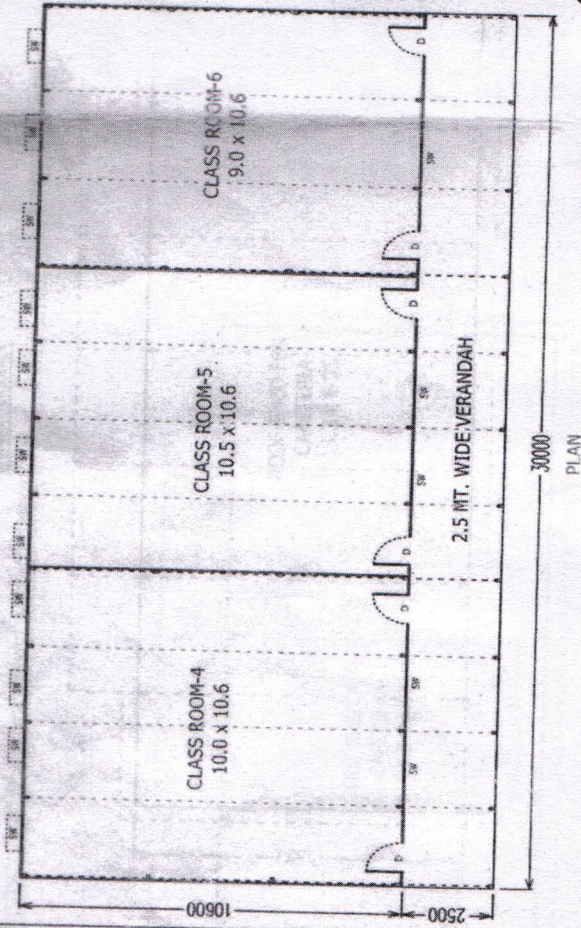

Roof

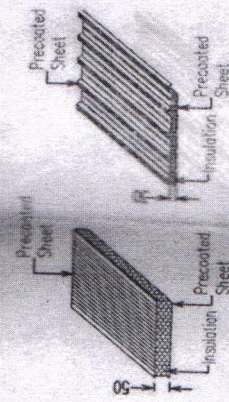

TYPICAL WALL SECTION
50MM THK.

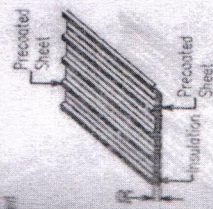

TYPICAL ROOF SECTION
30MM THK.

DOOR-WINDOW DETAIL		
D	DOOR	1000 x 2000mm.
D	ALL SLIDING WINDOW	1000 x 1200mm.

Handwritten signature

9/11/16

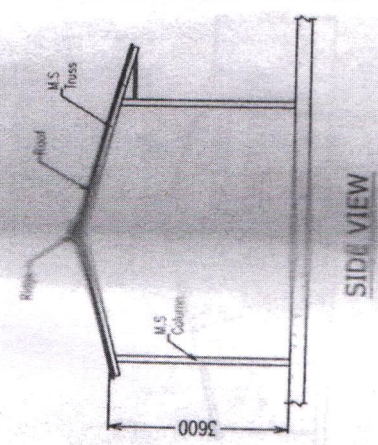

SIDE VIEW

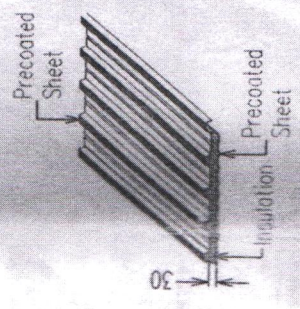

TYPICAL ROOF SECTION
30MM Thk.

Amrinder Singh
11/6/16

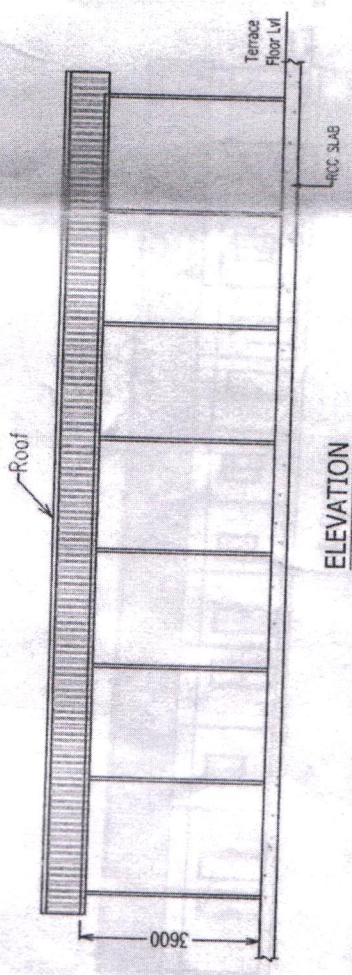

ELEVATION

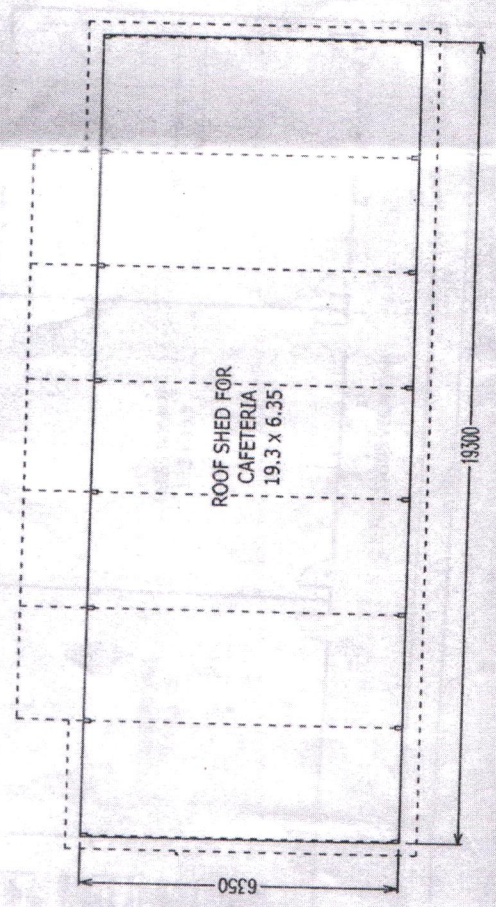

PLAN

Amrinder Singh
11/6/16

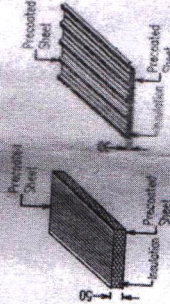
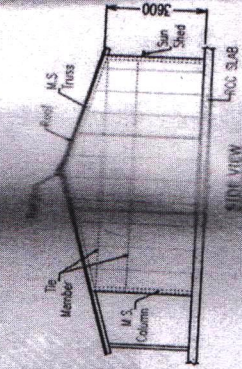

DOOR-WINDOW DETAIL	
D DOOR	1000 x 2000mm.
SW ALLU SLIDING WINDOW	1000 x 1500mm.
V VENT	400 x 472mm.

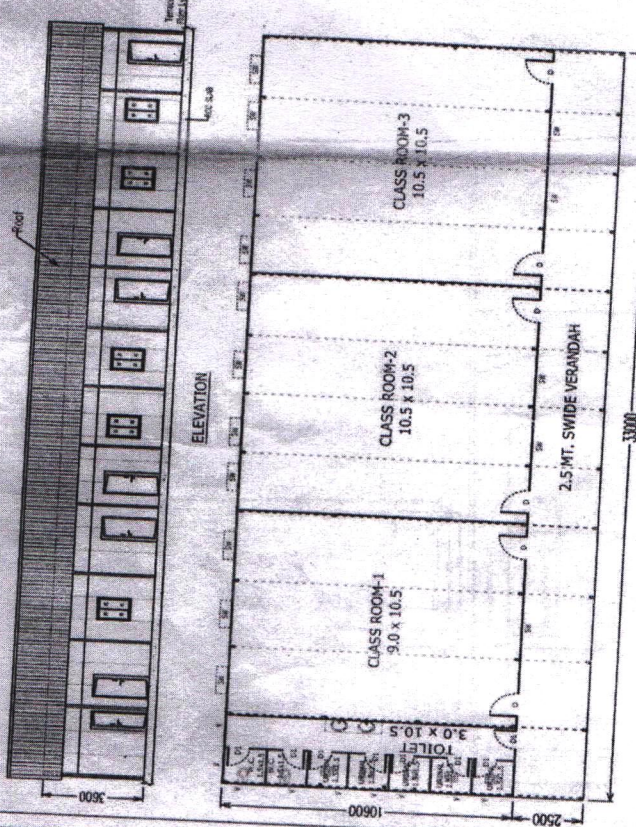

Suwarda 2/9/16

Suwarda 2/9/16

PLAN